

TERMOKUPULLAR

Sıcaklık ölçümünde kullanılan elementlerdir. Stoklarımızda mantel, bayonet, kafalı tip (Topuz Başı) termokupullar mevcuttur. İsteğe göre değişik çap, boy ve özelliklerde imal edilebilir. Buna ilaveten seramik tüp koruyucu kılıflı, quartz tüp koruyucu kılıflı, teflon koruyucu kılıflı olarak asidik ve korozif malzemeler içeren banyolarda kullanılmak üzere dizayn edilebilir.

- PT-100 - J type - K type - L Type - PTC 1000 - Mantel Tip Termokupullar
- Termokupullar

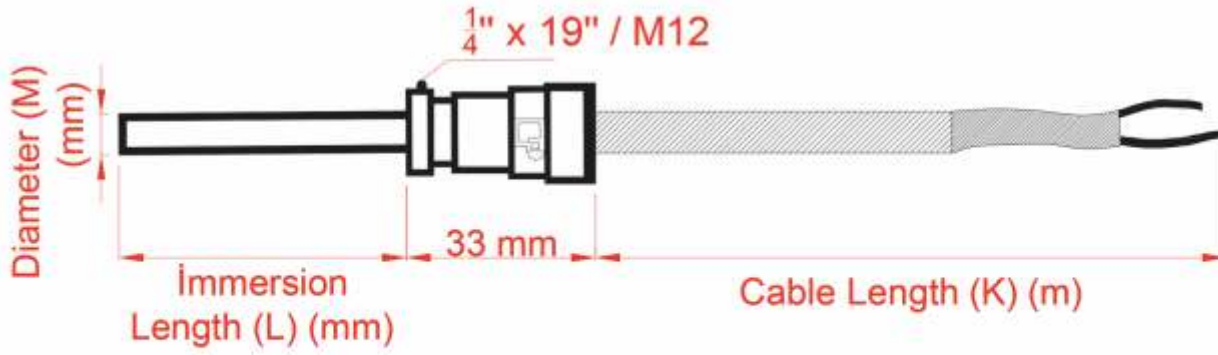

TC - M - L - K . E



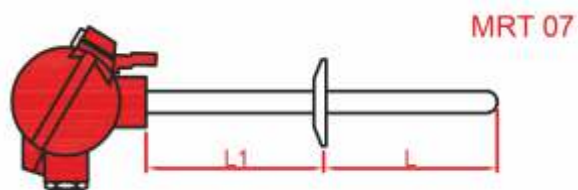
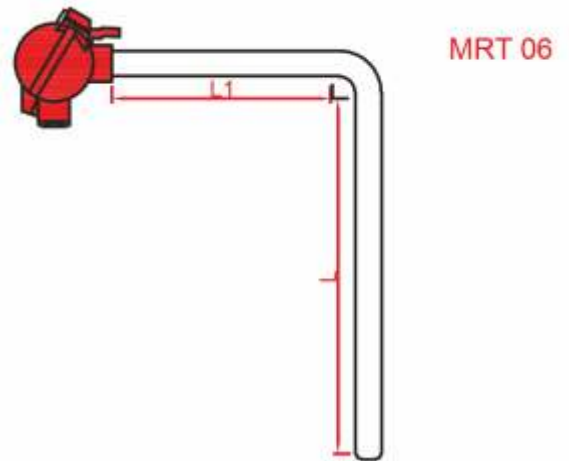
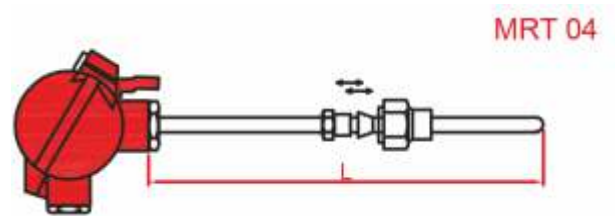
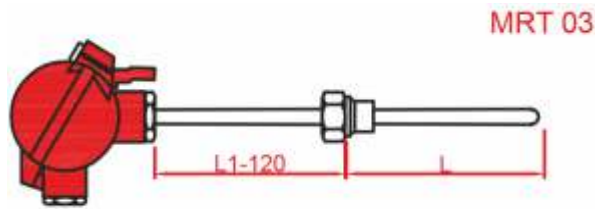
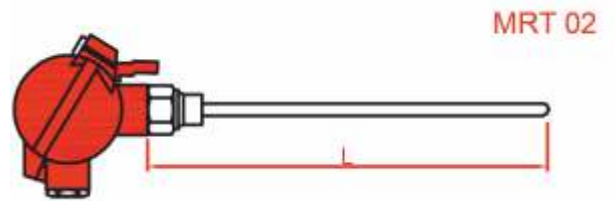
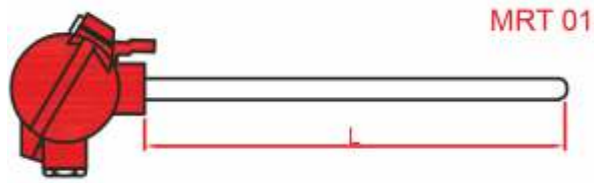

TERMOSTATLAR

Isıtma, soğutma, havalandırma yapan cihazların sıcaklık derecesini belli bir değerde tutmak için kullanılır. Bimetal termostatla 0°C ile 300°C arası Dijital olarak kullanılan tipler ise -40°C - 1200°C arasında kullanılan çeşitli cihazlar bulunmaktadır.

- Termostatlar



SICAKLIK KONTROL PANOLARI

